

KÜSCHALL COMPACT



Silla manual activa de chasis plegable por cruceta de aluminio hidroformado.
Opciones de pescantes extraíbles y abatibles int/externo o pescantes fijos.
Respaldo ajustable en ángulo y abatible sobre el asiento disponible como opción.
Doble cruceta a partir de ancho 44 cm.
Gran número de tallas y opciones.
Protectores de ropa antisalpicaduras fijos de composite. Opción de reposabrazos.
Peso máximo usuario : 130kg.
Peso : a partir de 9,6 kg* (pescantes fijos).
Peso de transporte: a partir de 6,7 kg* (pescantes fijos).
Nuevos Pack de Posicionamiento & Prevención de úlceras disponibles!
Configure su silla con el nuevo configurador visual: www.kuschall.com
Nos reservamos el derecho a una tolerancia de + - 1 cm en las medidas.
Nos reservamos el derecho a introducir cambios técnicos sin previo aviso!
Nota: producto configurado a medida i No se admiten devoluciones!
Compact SR-40F: Código provisional Prescripción (comunicado): S0008985 (Categoría SRM 040F)

Ortopedia :

Nombre usuario :

Dirección usuario :

Teléfono contacto :

Dirección entrega:

Número pedido :

Cantidad pedido :

Fecha pedido :

Por favor marque su elección con una cruz : Característica estándar Sin cargo

Peso usuario = **Kg**

Código	Descripción	P.V.P €	
MODELO			
DCA0012	<input checked="" type="checkbox"/> KÜSCHALL COMPACT 2.0	<input checked="" type="checkbox"/>	
MYKÜSCHALL			
DCA0000	MYKÜSCHALL FABRICACIÓN ESPECIAL : consultar precios y plazos de entrega con el departamento de Atención al Cliente		
PACK POSICIONAMIENTO			
DCA0220	PACK 1- POSICIONAMIENTO & PREVENCIÓN DE ÚLCERAS LIBRA/MX2 	INCLUYE : COJÍN MATRX LIBRA (DCA2720) RESPALDO MATRX MX2 (DCA2300 a DCA2315) CINTURÓN POSTURAL BODYPOINT EVOFLEX (DCA7810 a DCA7830) Anchura 360 mm solo posible con Profundidad 400/420 mm (NC : 1300, 1305, 1310, 1315, 1350, 1355, 1400, 1405, 1415, 1425, 7230)	1.093,15
DCA0230	PACK 2 - POSICIONAMIENTO & PREVENCIÓN DE ÚLCERAS LIBRA/ ELITE E2 	INCLUDE : MATRX LIBRA CUSHION (DCA2720) MATRX ELITE/ELITE DEEP E2 BACKREST (DCA2320-DCA2350) BODYPOINT EVOFLEX BELT (DCA7810 a DCA7830) Anchura 360 mm solo posible con Profundidad 400/420 mm (NC : 1300, 1305, 1310, 1315, 1400, 1405, 1415, 1425, 7230)	1.093,15
ASIENTO			
PARTE DELANTERA DEL CHASIS			
Ver tabla 2			
DCA1100	Pescantes abatibles , chasis estándar	(NC : 1900, 1902, 3040, 3140)	2.619,75
DCA1110	Pescantes fijos, 70° , chasis activo	(NC: 1700, 1705, 1710, 1715, 1720, 1725, 1730, 1800, 1805, 3000, 3010, 3020, 3030, 3100, 3110, 3120, 3130)	2.619,75
DCA1120	Pescantes fijos 80° , chasis dinámico	Ángulo de asiento mínimo (FSTF vs RSTF): 30 MM (NC : 1700, 1705, 1710, 1715, 1720, 1725, 1730, 1780, 1800, 1805, 1962, 3000, 3010, 3020, 3030, 3100, 3110, 3120, 3130, 5300, 5350, 5400, 5450, 5500, 5550, 5600, 5650)	2.619,75
DCA1130	Pescantes fijos 70° , chasis incurvado (aducción)	Plazo de entrega adicional +10 días (NC : 1300, 1305, 1700, 1705, 1710, 1715, 1720, 1725, 1730, 1800, 1805, 3000, 3010, 3020, 3030, 3100, 3110, 3120, 3130)	2.782,50
DCA1140	Pescantes fijos 80° , chasis incurvado (aducción)	Ángulo de asiento mínimo (FSTF vs RSTF): 30 MM Plazo de entrega adicional +10 días (NC : 1300, 1305, 1700, 1705, 1710, 1715, 1720, 1725, 1730, 1780, 1800, 1805, 1962, 3000, 3010, 3020, 3030, 3100, 3110, 3120, 3130, 5550, 5600, 5650)	2.782,50
ANCHURA ASIENTO (SW)			
DCA1300	280 MM Cruceta simple	(NC : 1600, 2210, 2300 a 2357, 2490, 2710, 2720, 2740, 2742, 2744, 2746, 2748, 2750, 2860, 3020 3030, 3120, 3130, 3260, 6000, 6010, 8450)	32,45



Cinturón BODYPOINT EVOFLEX GRATIS!!!! por la compra del PACK 1 o 2



Código	Descripción			P.V.P €
DCA1305	300 MM	Cruceta simple	(NC : 1600, 2210, 2300 a 2357, 2490, 2710, 2720, 2740, 2742, 2744, 2746, 2750, 3020, 3030, 3120, 3130, 3260, 6000, 6010, 8450)	32,45
DCA1310	320 MM	Cruceta simple	(NC : 1600, 2300 a 2357, 2490, 2710, 2720, 2740, 2742, 2744, 2746, 2748, 2750, 3020, 3030, 3120, 3130, 3260, 6000, 6010, 8450)	32,45
DCA1315	340 MM	Cruceta simple	(NC : 1600, 2300 a 2357, 2490, 2710, 2720, 2740, 2742, 2744, 2746, 2748, 2750, 3020, 3030, 3120, 3130, 6000, 6010, 8450)	○
DCA1320	360 MM	Cruceta simple	(NC : 2364, 2366, 2368, 2370, 2372, 2490, 2710, 2742, 2744, 2746, 2748, 3020, 3030, 3120, 3130)	○
DCA1325	380 MM	Cruceta simple	(NC : 2366, 2368, 2370, 2372, 2490, 2742, 2744, 3020, 3030, 3120, 3130)	○
DCA1330	400 MM	Cruceta simple	(NC : 2360, 2366, 2368, 2370, 2372, 2744)	○
DCA1335	420 MM	Cruceta simple	(NC : 2360, 2362, 2368, 2370, 2372, 2746)	○
DCA1340	440 MM	Doble cruceta	(NC : 2360, 2362, 2364, 2370, 2372, 2740, 2742)	○
DCA1345	460 MM	Doble cruceta	(NC : 2360, 2362, 2364, 2372, 2740, 2742, 2744)	○
DCA1350	480 MM	Doble cruceta	(NC : 2300, 2305, 2310, 2315, 2345, 2360, 2362, 2364, 2366, 2740, 2742, 2744)	○
DCA1355	500 MM	Doble cruceta	(NC : 2210, 2300, 2305, 2310, 2315, 2345, 2360, 2362, 2364, 2366, 2368, 2740, 2742, 2744, 2746)	32,45
PROFUNDIDAD ASIENTO (SD)				
DCA1400	320 MM	(NC : 2155, 2160, 2710, 2720, 2740, 2742, 2744, 2746, 2748, 2750, 2860, 2910, 5650)		32,45
DCA1405	340 MM	(NC : 2155, 2160, 2710, 2720, 2740, 2742, 2744, 2746, 2910, 5650)		32,45
DCA1415	360 MM	(NC : 2710, 2720, 2742, 2744, 2746, 2748, 2860, 5650)		○
DCA1425	380 MM	(NC : 2720, 2744, 5650)		○
DCA1435	◆ 400 MM	(NC : 2744)		◆
DCA1445	420 MM			○
DCA1460	440 MM	(NC : 2740, 2742)		○
DCA1470	460 MM	(NC : 2740, 2742, 2744)		○
DCA1480	480 MM	(NC : 2740, 2742, 2744, 2746, 2748)		○
DCA1490	500 MM	(NC : 2710, 2740, 2742, 2744, 2746, 2748)		○
ALTURA RESPALDO (BH)				
Con respaldo MATRX BACKRESTS : Solo determina la altura de las empuñaduras				
DCA1615	300 MM		(NC : 2140, 2210, 2240, 2595, 7600)	○
DCA1620	315 MM		(NC : 2140, 2210, 2240, 2595, 7600)	○
DCA1625	330 MM		(NC : 2140, 2210, 2240, 2595, 7600)	○
DCA1630	345 MM		(NC : 2210, 2240, 2595, 7600)	○
DCA1635	360 MM		(NC : 2240, 2595, 7600)	○
DCA1640	◆ 375 MM		(NC : 2240, 2595, 7600)	◆
DCA1645	390 MM		(NC : 2240, 2595, 7600)	○
DCA1650	405 MM		(NC : 2240)	○
DCA1655	420 MM		(NC : 2240)	○
DCA1660	435 MM		(NC : 2240)	○
DCA1665	450 MM		(NC : 2240)	○
DCA1670	465 MM		(NC : 2240)	○
DCA1675	480 MM		(NC : 2240)	○
DCA1680	495 MM		(NC : 2240)	○
DCA1685	510 MM		(NC : 2240)	○
ALTURA DELANTERA ASIENTO SUELO (FSTF)				
Ver tabla 1, 5				
DCA1700	370 MM	Chasis Hemi (solo con pescantes abatibles)	(NC: 1810 to 1870, 1932 to 1962, 3030, 3130, 6000, 6010, 6410, 6420, 7600)	○
DCA1705	380 MM	Chasis Hemi (solo con pescantes abatibles)	(NC: 1815 a 1870, 1934 to 1962, 3030, 3130, 6000, 6010, 6410, 6420, 7600)	○
DCA1710	390 MM	Chasis Hemi (solo con pescantes abatibles)	(NC: 1820 a 1870, 1936 to 1962, , 3030, 3130, 6000, 6010, 6410, 6420, 7600)	○
DCA1715	400 MM	Chasis Hemi (solo con pescantes abatibles)	(NC: 1825 a 1870, 1938 to 1962,, 3030,, 3130, 6000, 6010, 6410, 6420, 7600)	○
DCA1720	410 MM	Chasis Hemi (solo con pescantes abatibles)	(NC : 1830 to 1870, 1940 to 1962, 3030, 3130)	○

Código	Descripción			P.V.P €
DCA1725	420 MM	Chasis Hemi (solo con pescantes abatibles)	(NC : 1835 to 1870, 1942 to 1962)	○
DCA1730	430 MM	Chasis Hemi (solo con pescantes abatibles)	(NC : 1840 to 1870, 1944 to 1962)	○
DCA1735	440 MM	(NC : 1845 to 1870, 1946 to 1962)		○
DCA1740	450 MM	(NC : 1850 to 1870, 1948 to 1962)		○
DCA1745	460 MM	(NC : 1855 to 1870, 1950 to 1962)		○
DCA1750	470 MM	(NC : 1800, 1860 to 1870, 1952 to 1962)		○
DCA1755	480 MM	(NC : 1800, 1805, 1865, 1870, 1954 to 1962)		○
DCA1760	490 MM	(NC : 1800, 1805, 1810, 1956 to 1962)		○
DCA1765	◆ 500 MM	(NC : 1800, 1805, 1810, 1815, 1958 to 1962)		◆
DCA1770	510 MM	(NC: 1800 to 1820, 1960, 1962)		○
DCA1775	520 MM	(NC: 1800 to 1825, 1962)		○
DCA1780	530 MM	(NC: 1800 to 1830)		○
ALTURA TRASERA ASIENTO SUELO (RSTF)				
Ver tabla 5				
DCA1805	370 MM	Solo con ruedas de 22" y pescantes abatibles	(NC: 6000, 6010, 6410, 6420, 6430, 7500, 7510, 7520)	○
DCA1810	380 MM		(NC : 6000, 6010, 6410, 6420, 6430)	○
DCA1815	390 MM		(NC : 6420, 6430)	○
DCA1820	400 MM		(NC : 6420, 6430)	○
DCA1825	410 MM		(NC : 6420, 6430)	○
DCA1830	420 MM			○
DCA1835	430 MM			○
DCA1840	440 MM			○
DCA1845	◆ 450 MM			◆
DCA1850	460 MM			○
DCA1855	470 MM			○
DCA1860	480 MM		(NC : 6400)	○
DCA1865	490 MM		(NC : 6400)	○
DCA1870	500 MM		(NC : 6000, 6010, 6400, 6410)	○
LARGO DE PIERNA (LLL)				
Ver tabla 2				
DCA1900	200 MM		(NC: 3030, 3130)	○
DCA1902	210 MM		(NC: 3030, 3130)	○
DCA1904	220 MM		(NC: 3030, 3130)	○
DCA1906	230 MM		(NC: 3030, 3130)	○
DCA1908	240 MM		(NC: 3030, 3130)	○
DCA1910	250 MM		(NC: 3030, 3130)	○
DCA1912	260 MM		(NC: 3030, 3130)	○
DCA1914	270 MM		(NC: 3030, 3130)	○
DCA1916	280 MM		(NC: 3030, 3130)	○
DCA1918	290 MM		(NC: 3030, 3130)	○
DCA1920	300 MM		(NC: 3030, 3130)	○
DCA1922	310 MM		(NC: 3030, 3130)	○
DCA1924	320 MM		(NC: 3030, 3130)	○
DCA1926	330 MM		(NC: 3030, 3130)	○
DCA1928	340 MM		(NC: 3030, 3130)	○
DCA1930	350 MM		(NC: 3030, 3130)	○
DCA1932	360 MM		(NC: 3030, 3130)	○
DCA1934	370 MM		(NC: 3030, 3130)	○
DCA1936	380 MM			○
DCA1938	390 MM			○
DCA1940	400 MM			○
DCA1942	410 MM			○
DCA1944	420 MM			○
DCA1946	◆ 430 MM			◆
DCA1948	440 MM			○
DCA1950	450 MM			○
DCA1952	460 MM			○
DCA1954	470 MM			○
DCA1956	480 MM			○
DCA1958	490 MM			○
DCA1960	500 MM			○
DCA1962	510 MM		(NC : 3000, 3100, 3010, 3110)	○
RESPALDO				
TUBO RESPALDO				
DCA2110	◆ Tubos fijos (90°)	Seleccionar para pedir respaldo a medida tipo MATRX	(NC : 2155, 2160, 2165, 2170, 2175, 2180)	◆

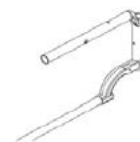

Chasis Hemi
Obligatorio con opciones 1700 a 1730 y con pescantes abatibles)

RSTF / FSTF : pescantes fijos

Pescantes fijos 70° :
RSTF = "FSTF - 100 mm " a "FSTF - 0 mm"

Pescantes fijos 80° :
RSTF = "FSTF - 100 mm " a "FSTF - 30 mm"

RSTF / FSTF : Pescantes abatibles

Pescantes 70° & 80° :
RSTF = "FSTF - 100 mm " a "FSTF - 0 mm"

RSTF / Tamaño rueda trasera

22" : 360-470 mm

24" : 390-490 mm

25" : 420-500 mm

26" : 420-500 mm

LLL / FSTF : Pescantes fijos

Pescantes fijos 70° :
LLL max. = "FSTF - 20 mm"

Pescantes fijos 80° :
LLL max. = "FSTF - 30 mm"

LLL / FSTF : Pescantes abatibles

Pescantes fijos 70° :
LLL max. = "FSTF 20 mm"

Pescantes fijos 80° :
LLL max. = "FSTF 30 mm"

LLL / paleta

Dependiendo de la configuración, la paleta puede ser de montaje superior - ver tabla 2

LLL / FSTF : Reposapiés elevables

Posición 75°
LLL max = FSTF -40 mm
LLL min = 380 mm

Posición 60°
LLL max = FSTF + 00 mm
LLL min = 380 mm

Código	Descripción			P.V.P €
DCA2120	Tubos con ángulo lumbar (7°)			(NC : 2155, 2160, 2165, 2170, 2175, 2180, 2300 a 2357) 43,74
DCA2130	Respaldo ajustable en ángulo	Por favor, seleccione el ángulo BH > 330 MM Solo	(NC : 2300 a 2357)	215,59
DCA2140	Respaldo ajustable en ángulo y abatible (sobre el asiento)	Por favor, seleccione el ángulo	(NC : 2180, 2300 a 2357, 2430)	368,30
ANGULO RESPALDO (Con respecto al asiento)				
DCA2155	Ángulo respaldo, ajustado a 82° (hacia delante)			○
DCA2160	Ángulo respaldo, ajustado a 86°			○
DCA2165	Ángulo respaldo, ajustado a 90°			○
DCA2170	Ángulo respaldo, ajustado a 94°	No posible con respaldo abatible (DCA2140) + respaldo MATRX		○
DCA2175	Ángulo respaldo, ajustado a 98°	No posible con respaldo abatible (DCA2140) + respaldo MATRX		○
DCA2180	Ángulo respaldo, ajustado a 102° (hacia atrás)			○
TAPIZADO RESPALDO				
DCA2200	◆ Tapizado estándar, acolchado	(NC : 2300 a 2357, 2400, 2430, 2595)		◆
DCA2210	Tapizado ligero (anti transpirable)	No posible con SW ≤ 320 MM / SW 500 MM / BH < 360 MM	(NC : 2300 a 2357, 2430, 2595)	159,58
DCA2220	Tapizado ajustable en tensión PREMIUM negro, bolsillo trasero	(NC : 2300 a 2357)		119,00
DCA2230	Tapizado ajustable en tensión Aero back, transpirable, bolsillo trasero	(NC : 2300 a 2357)		200,41
DCA2240	Sin tapizado de respaldo	Obligatorio para seleccionar respaldo a medida tipo Matrx	(NC: 2430, 2595)	○
RESPALDOS MATRX				
La altura corresponde a la altura efectiva del respaldo MATRX				
DCA2300	Matrx MX2, altura 150 mm con fijación Quick-Release (par)	No posible con SW > 460 MM y SW < 360MM	(NC : 2370, 2372, 2490)	770,00
DCA2305	Matrx MX2, altura 230 mm con fijación Quick-Release (par)	No posible con SW > 460 MM y SW < 360MM	(NC : 2370, 2372, 2490)	770,00
DCA2310	Matrx MX2, altura 305 mm con fijación Quick-Release (par)	No posible con SW > 460 MM y SW < 360MM	(NC : 2370, 2372, 2490)	770,00
DCA2315	Matrx MX2, altura 405 mm con fijación Quick-Release (par)	No posible con SW > 460 MM y SW < 360MM	(NC : 2370, 2372, 2490)	770,00
DCA2316	ELITE DEEP E2 , altura 160 mm con fijación Mini incluida (par)	No posible con SW < 360MM	(NC : 2490)	770,00
DCA2317	ELITE DEEP E2 , altura 210 mm con fijación Mini incluida (par)	No posible con SW < 360MM	(NC : 2490)	770,00
DCA2318	ELITE DEEP E2 , altura 260 mm con fijación Mini incluida (par)	No posible con SW < 360MM	(NC : 2490)	770,00
DCA2320	Elite Deep E2, altura 310 mm con fijación Mini incluida (par)	No posible con SW < 360MM	(NC : 2490)	770,00
DCA2322	ELITE DEEP E2, altura 360 mm con fijación Mini incluida (par)	No posible con SW < 360MM	(NC : 2490)	770,00
DCA2325	Elite Deep E2, altura 410 mm con fijación Mini incluida (par)	No posible con SW < 360MM	(NC : 2490)	770,00
DCA2330	Elite Deep E2, altura 460 mm con fijación Estándar incluida (par)	No posible con SW < 360MM	(NC : 2490)	770,00
DCA2331	ELITE DEEP E2, altura 510 mm con fijación Estándar incluida (par)	No posible con SW < 360MM	(NC : 2490)	770,00
DCA2332	ELITE E2, altura 160 mm con fijación Mini incluida (par)	No posible con SW < 360MM	(NC : 2490)	770,00
DCA2334	ELITE E2, altura 210 mm con fijación Mini incluida (par)	No posible con SW < 360MM	(NC : 2490)	770,00
DCA2335	Elite E2, altura 260 mm con fijación Mini incluida (par)	No posible con SW < 360MM	(NC : 2490)	770,00
DCA2340	Elite E2, altura 310 mm con fijación Mini incluida (par)	No posible con SW < 360MM	(NC : 2490)	770,00

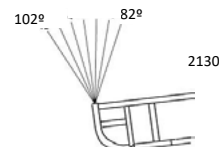
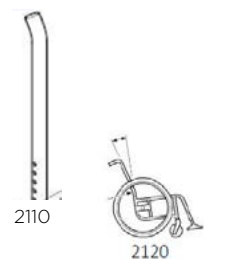

INFORMACIÓN IMPORTANTE RELACIONADA CON RESPALDOS MATRX o A MEDIDA
En caso de montar un respaldo Matrx o a medida, asegúrese que la parte más alta del respaldo no esté situada a más de 590 mm a partir del asiento



Código	Descripción			P.V.P €
DCA2345	Elite E2, altura 360 mm con fijación Mini incluida (par)	No posible con SW > 460 MM y SW < 360MM	(NC : 2490)	770,00
DCA2350	Elite E2, 410 mm con fijación Mini incluida (par)	No posible con SW < 360MM	(NC : 2490)	770,00
DCA2355	ELITE E2, altura 460 mm con fijación Estándar incluida (par)	No posible con SW < 360MM	(NC : 2490)	770,00
DCA2357	ELITE E2, altura 510 mm con fijación Estándar incluida (par)	No posible con SW < 360MM	(NC : 2490)	770,00
ANCHURA RESPALDO MATRX				
DCA2360	360 MM	Anchora de tronco (indicativa) : 265 MM		○
DCA2362	380 MM	Anchora de tronco (indicativa) : 290 MM		○
DCA2364	410 MM	Anchora de tronco (indicativa) : 315 MM		○
DCA2366	430 MM	Anchora de tronco (indicativa) : 340 MM		○
DCA2368	460 MM	Anchora de tronco (indicativa) : 370 MM		○
DCA2370	480 MM	Anchora de tronco (indicativa) : 390 MM		○
DCA2372	510 MM	Anchora de tronco (indicativa) : 420 MM		○
PUÑOS DE EMPUJE				
DCA2400	Sin puños	Con respaldo Matrx : montaje a 350 mm desde asiento (aprox)	(NC : 2490)	○
DCA2410	Puños fijos, mini	Con respaldo Matrx : montaje a 475 mm desde asiento (aprox)	(NC : 2490, 6580)	59,05
DCA2420	◆ Puños fijos, largos	Con respaldo Matrx : montaje a 475 mm desde asiento (aprox)		◆
DCA2430	Puños ajustables en altura, montaje trasero	Con respaldo Matrx : montaje a 600 mm desde asiento (aprox)	(NC : 2490, 3520, 3620)	240,01
DCA2440	Puños ajustables en altura, integrados		(NC : 2490, 2595)	216,99
DCA2450	Puños plegables	Con respaldo Matrx : montaje a 450 mm desde asiento (aprox)	(NC : 2490, 2595, 6580)	263,06
REPOSACAEBZAS				
DCA2490	Reposacabezas envolvente		(NC : 2595, 6580)	147,36
BARRA ESTABILIZADORA RESPALDO				
DCA2595	Barra estabilizadora de respaldo, abatible y desmontable	No posible con BH ≤ 390 MM		150,33
ASIENTO				
TAPIZADO ASIENTO				
DCA2610	◆ Tapizado estándar con una cincha central con cierre gancho-bucle (suave)			◆
DCA2620	Tapizado con una cincha central con cierre gancho-bucle (suave) y dos cinchas en las partes laterales (rugosas)			27,04
COJÍN ASIENTO				
DCA2700	Cojín asiento estándar, 60 mm, espuma doble con visco top		(NC : 2810, 2820, 2830, 2840, 2850)	91,87
DCA2710	MATRX FLO-TECH LITE - Altura 78 mm		(NC : 2810, 2820, 2830, 2840, 2850)	105,43
DCA2720	MATRX LIBRA (tejido negro) - altura 83 mm	No posible con SW ≤ 340 MM & SD ≤ 380 MM	SW 360 MM Solo posible con SD 400/420 MM Plazo de entrega adicional +7 días	(NC : 2810, 2820, 2830, 2840, 2850) 323,15
DCA2740	CLASSIC VISCO 375 X 400 MM - altura 75 mm	Solo para usuarios hasta 50 KG		(NC : 2810, 2820, 2830, 2840, 2850) 105,43
DCA2742	CLASSIC VISCO 405 X 400 MM - altura 75 mm	Solo para usuarios hasta 100 KG		(NC : 2810, 2820, 2830, 2840, 2850) 105,43
DCA2744	CLASSIC VISCO 430 X 430 MM - altura 75 mm	Solo para usuarios hasta 100 KG		(NC : 2810, 2820, 2830, 2840, 2850) 105,43
DCA2746	CLASSIC VISCO 455 X 400 MM - altura 75 mm	Solo para usuarios hasta 100 KG		(NC : 2810, 2820, 2830, 2840, 2850) 105,43
DCA2748	CONTOUR VISCO NG altura 100 mm			(NC : 2810, 2820, 2830, 2840, 2850) 105,43
BOLSA DE ASIENTO				
DCA2800	Bolsa asiento delantera, desmontable			74,49
ACCESORIOS MATRX LIBRA				
BASE RÍGIDA				
DCA2860	Base rígida			46,81

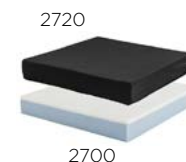

Código	Descripción		P.V.P €
BOLSA TAPIZADO DE ASIENTO			
DCA2910	Bolsa grande de tela (fijación cinchas cierre gancho-bucle) debajo del tapizado de asiento	No posible con SD ≤ 340 MM	59,95
REPOSAPIÉS Y PALETAS			
PESCANTES ABATIBLES Ver tabla 2, 6			
PESCANTE DERECHO			
DCA3000	Pescante derecho, abatible y desmontable 70° (ángulo abierto)	Paletas obligatorias	(NC : 3110) ○
DCA3010	◆ Pescante derecho, abatible y desmontable 80° (ángulo semi abierto)	Paletas obligatorias	(NC : 3100, 5650) ◆
DCA3020	Soporte amputado, derecho		(NC : 3280, 3300, 3305, 3310) 155,98
DCA3030	Reposapiernas derecho, ajustable en ángulo 0° a 75° con apoya pantorrilla ajustable, UL desde 380 hasta 580 mm	Paleta ajustable en ángulo, profundidad y anchura	(NC : 3280, 3300, 3305, 3310) 142,69
DCA3040	Pescante fijo derecho	Solo si opción 1130 o 1140 seleccionada	○
PESCANTE IZQUIERDO			
DCA3100	Pescante izquierdo, abatible y desmontable 70° (ángulo abierto)	Paletas obligatorias	○
DCA3110	◆ Pescante izquierdo, abatible y desmontable 80° (ángulo semi abierto)	Paletas obligatorias	(NC : 5650) ◆
DCA3120	Soporte amputado, izquierdo		(NC : 3280, 3300, 3305, 3310) 155,98
DCA3130	Reposapiernas izquierdo, ajustable en ángulo 0° a 75° con apoya pantorrilla ajustable, UL desde 380 hasta 580 mm	Paleta ajustable en ángulo, profundidad y anchura	(NC : 3280, 3300, 3305, 3310) 142,69
DCA3140	Pescantes fijos izquierdo	Solo si opción 1130 o 1140 seleccionada	○
PALETAS DOBLES O MONOBLOC			
PALETA			
DCA3260	◆ 2 piezas abatibles, composite - Nueva!	No posible con SW < 340 MM, LLL < 260 MM, chasis incurvado (aducción) SW < 380 MM	◆
DCA3270	2 piezas abaitbles, ajustables en ángulo y profundidad, carbono		(NC : 3310) 253,03
DCA3280	1 pieza- ajustable en ángulo y abatible, carbono	No posible con LLL < 300 MM	(NC : 3310) 272,50
SOPORTE PARA LOS PIES			
DCA3300	Cincha apoya pantorrilla montada en el chasis		○
DCA3305	Cincha apoya pantorrilla montada en la parte trasera de los pescantes		○
DCA3310	◆ Taloneras (par)		◆
REPOSABRAZOS/PROTECTORES/ANTISALPICADURAS			
PROTECTORES DE ROPA, ANTISALPICADURAS Ver tabla 3			
DCA3400	Protectores de ropa de composite, fijos - Nuevo!		(NC: 3500, 3510, 3530, 3540, 3550, 3600, 3610, 3630, 3640, 3650, 7600, 8450) ○
DCA3405	Protectores de ropa desmontables, composite ¡Nuevos!		(NC : 3500, 3510, 3530, 3540, 3550, 3600, 3610, 3630, 3640, 3650, 7600, 8450) ○
DCA3410	Protectores de ropa de carbono, fijos - Nuevo!		(NC : 3500, 3510, 3530, 3540, 3550, 3600, 3610, 3630, 3640, 3650, 7600, 8450) 75,71
DCA3425	◆ Protectores de ropa antisalpicaduras de composite, fijos - Nuevo!		(NC : 3500, 3510, 3530, 3540, 3550, 3600, 3610, 3630, 3640, 3650, 6000, 6010, 6140, 6580, 7600, 8450) ◆
DCA3430	Protectores de ropa antisalpicaduras de carbono, fijos - Nuevo!	No posible con FSTF < 410 MM	(NC : 3500, 3510, 3530, 3540, 3550, 3600, 3610, 3630, 3640, 3650, 6000, 6010, 6140, 6150, 6580, 6950, 7600, 8450) 86,52
DCA3440	Protectores de ropa antisalpicaduras de carbono, desmontables - Nuevo!	Incrementa ancho total: + 20 mm	(NC : 3500, 3510, 3530, 3540, 3550, 3600, 3610, 3630, 3640, 3650, 6140, 6150, 8450) 151,41
DCA3450	Protectores de ropa antisalpicaduras de composite, desmontables - Nuevo!	Incrementa ancho total: + 20 mm	(NC : 3500, 3510, 3530, 3540, 3550, 3600, 3610, 3630, 3640, 3650, 6140, 8450) 64,89



2800



2860



2910



3020 / 3120



3030 / 3130

Reposapiés :
Tome nota que los reposapiés especiales como el reposapiés para amputado solo son compatibles con anchuras > 380 mm.



3260



3270



3280



3400



3430



3440



3450



3400

Código	Descripción		P.V.P €
REPOSABRAZOS DERECHO			
DCA3500	Reposabrazos ajustables en altura (con herramienta), desmontable, corto, sin bloqueo, incluye protector de ropa de carbono		117,62
DCA3510	Reposabrazos ajustables en altura (con herramienta), desmontable, largo, sin bloqueo, incluye protector de ropa de carbono	(NC : 6950, 8450)	117,62
DCA3520	Reposabrazos tubular, sin bloqueo, ajustable en altura, desmontable, abatible, acolchado confort	(NC : 6950)	117,62
DCA3530	Reposabrazos Kuschall, contorno negro, sistema bloqueo, ajustable en altura, desmontable, abatible, almohadilla corta (incluye funda neopreno negra)	(NC : 6130, 6140, 6150)	133,51
DCA3540	Reposabrazos HEMI (Rea), ajustable en altura, desmontable, abatible, acolchado Hemi y funda de neopreno negro	(NC : 6130, 6140, 6150, 8450)	173,04
REPOSABRAZOS IZQUIERDO			
DCA3600	Reposabrazos ajustables en altura (con herramienta), desmontable, corto, sin bloqueo, incluye protector de ropa de carbono		117,62
DCA3610	Reposabrazos ajustables en altura (con herramienta), desmontable, largo, sin bloqueo, incluye protector de ropa de carbono		117,62
DCA3620	Reposabrazos tubular, sin bloqueo, ajustable en altura, desmontable, abatible, acolchado confort	(NC : 6950, 8450)	117,62
DCA3630	Reposabrazos Kuschall, contorno negro, sistema bloqueo, ajustable en altura, desmontable, abatible, almohadilla corta (incluye funda neopreno negra)	(NC : 6130, 6140, 6150)	133,51
DCA3640	Reposabrazos HEMI (Rea), ajustable en altura, desmontable, abatible, acolchado Hemi y funda de neopreno negro	(NC : 6130, 6140, 6150, 8450)	173,04
COLORES DE CHASIS Y PERSONALIZACIÓN (ver configurador visual Kuschall para personalizar su silla K-series)			
COLOR DE CHASIS			
DCA4000	Negro espacial (RAL 9005)	Personalización con calcomanía BOLD o TAG	○
DCA4010	Gris antracita (RAL 7016)	Personalización con calcomanía BOLD o TAG	○
DCA4020	Blanco puro (RAL 9016)	Personalización con calcomanía BOLD o TAG (NC : 4220)	○
DCA4030	Rojo Carmin (RAL 3002)	Personalización con calcomanía BOLD o TAG	○
DCA4040	Azul Celeste (RAL 5017)	Personalización con calcomanía BOLD o TAG	○
DCA4060	Amarillo intenso (RAL 1016)	Plazo de entrega adicional +10 días	Personalización con calcomanía BOLD o TAG 270,38
DCA4070	Violeta atómico (CONSULTAR DISPONIBILIDAD)	Plazo de entrega adicional +10 días	Personalización con calcomanía BOLD o TAG 270,38
DCA4100	Negro brillante (RAL 9005)	Plazo de entrega adicional +10 días	Personalización con calcomanía BOLD o TAG 270,38
DCA4130	Gris plateado (RAL 9006)	Plazo de entrega adicional +10 días	Personalización con calcomanía BOLD o TAG 270,38
DCA4140	Azul real	Plazo de entrega adicional +10 días	Personalización con calcomanía BOLD o TAG 270,38
DCA4150	Rojo rubí (RAL 3003)	Plazo de entrega adicional +10 días	Personalización con calcomanía BOLD o TAG 270,38
DCA4170	Naranja dinámica	Plazo de entrega adicional +10 días	Personalización con calcomanía BOLD o TAG 270,38
DCA4180	Verde forestal (RAL 6029)	Plazo de entrega adicional +10 días	Personalización con calcomanía BOLD o TAG 270,38
DCA4050	Color especial	Consultar precios y plazos con Departamento de Atención al Cliente	Facilitar código RAL/ información adicional (NC : 4190)
ESTILO DE CALCOMANÍA			
DCA4190	BOLD	(NC : 4300, 4310)	102,74
DCA4195	◆ TAG	(NC : 4200, 4210, 4220, 4230, 4240, 4250)	◆
DCA4197	Sin Calcomanía (solo Logo Kuschall)	(NC : 4200, 4210, 4220, 4230, 4240, 4250, 4300, 4310)	○
Color de calcomanía BOLD (calcomanías en la parte delantera de los flancos)			
DCA4200	Negro		○
DCA4210	Gris oscuro		○
DCA4220	Gris claro		○
DCA4230	Rojo		○
DCA4240	Azul		○
DCA4250	Dorado		○
TAG COLOR			
DCA4300	Negro	(NC : 4300, 4310)	○

Atención:
El reposabrazos hemi viene montado en el reposabrazos REA y no en reposabrazos Kuschall



3600/3610



3620



3640

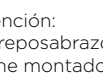

3530/3630

Atención:
El reposabrazos hemi viene montado en el reposabrazos REA y no en reposabrazos Kuschall



BOLD



TAG



Código	Descripción		P.V.P €
DCA4310	Rojo	(NC : 4200, 4210, 4220, 4230, 4240, 4250)	○
DCA4197	Sin calcomanía, Solo logo Küschall	(NC : 4200, 4210, 4220, 4230, 4240, 4250, 4300, 4310)	
RUEDAS DELANTERAS			
Ver tabla 1			
DCA5050	4" Everyday cubierta negra		○
DCA5100	4" Confort cubierta negra		○
DCA5150	4" Starec llanta negra, cubierta negra		104,99
DCA5200	4" Frog leg con llanta de aluminio negro, cubierta negra		104,99
DCA5250	4" Frog leg con llanta de aluminio plata, cubierta negra		104,99
DCA5300	5" Everyday con cubierta negra		○
DCA5350	◆ 5" Confort con cubierta negra		◆
DCA5400	5" Starec llanta negra, cubierta negra		111,56
DCA5450	5" Frog leg con llanta de aluminio negro, cubierta negra		111,56
DCA5500	5" Frog leg con llanta de aluminio plata, cubierta negra		111,56
DCA5550	6" Confort con cubierta negra		○
DCA5600	6" neumática		35,69
DCA5650	7" Confort con cubierta negra		○
RUEDAS TRASERAS			
DOBLE ARO			
DCA6000	DOBLE ARO LADO DERECHO (con rueda ligera 7 bares, aros de aluminio)	(NC : 6040, 6130, 6140, 6150, 6300, 6400, 6420, 6430, 6500, 6510, 6520, 6550, 6580, 6680, 6840, 6900, 6910, 6950, 8650, 8680)	515,00
DCA6010	DOBLE ARO LADO IZQUIERDO (con rueda ligera 7 bares, aros de aluminio)	(NC : 6040, 6130, 6140, 6150, 6300, 6400, 6420, 6430, 6500, 6510, 6520, 6550, 6580, 6680, 6840, 6900, 6910, 6950, 8650, 8680)	515,00
FIJACIÓN RUEDA TRASERA			
DCA6020	◆ Fijación estándar	(NC : 6140, 6150)	◆
DCA6040	Extensión rueda trasera	(NC: 6100, 6950)	86,61
POSICIÓN RUEDA TRASERA			
DCA6100	1a posición (la más activa)	(NC : 6580, 6840)	○
DCA6110	2a posición	(NC : 6950)	○
DCA6120	◆ 3a posición		◆
DCA6130	4a posición	(NC : 6950)	○
DCA6140	5a posición (solo con opción 6040)		○
DCA6150	6a posición (la más estable) - (Solo con opción 6040)		○
EJE DE DESMONTAJE RÁPIDO PARA TETRAS			
DCA6300	Eje de desmontaje rápido TETRA-CLIP	(NC: 6550, 6580, 6950)	114,36
TAMAÑO RUEDAS TRASERAS			
DCA6400	22"	(NC : 6500, 6520, 6550, 6560, 6625, 6630, 6660, 6760, 6710 6720, 6740,, 6760, 6770, 6950)	226,41
DCA6410	◆ 24"		◆
DCA6420	25"	(NC: 6500, 6510, 6580, 6600, 6525, 6660, 6700, 6710, 6720, 6760, 6770, 6900, 6910, 6950)	226,41
DCA6430	26"	(NC : 6500, 6520, 6550, 6600, 6625, 6630, 6660, 6720, 6740, 6750, 6760, 6770, 6840, 6950)	226,41
TIPO DE RUEDAS TRASERAS			
DCA6500	◆ Ruedas activas 24" (llantas, buje y radios radiales -negros - aros aluminio, neumáticos presión 7,5 bares)	Otros tipos de cubiertas posibles	(NC 6625 : todos los aros, todos los protectores de radios)
DCA6510	STAREC 22", 24", 26" radios Cruzados	Llanta negra y buje negro, radios cruzados negros para ruedas 24" y 26" / buje natural, radios color plata para ruedas 22", (NC 6625)	○
DCA6520	Ruedas PERFORMANCE 24", 25", llanta negra, buje Starec negro, radios cruzados negros	NC : 6660	369,53
DCA6550	Ruedas SPINERGY LXX 24", 25", llanta negra, buje negro, radios radiales negros	(NC : 6625, 6660,, 6910)	657,68
DCA6580	22", 24", 26" freno tambor para acompañante	(NC : 6625, 6660,, 6910)	465,05
CUBIERTA RUEDAS TRASERAS			
DCA6600	◆ 24" X 1" , MAXXIS LITE GUARD, Protección antipinchazo SilverShield polifibra (0,45 mm)	NUEVO	◆
DCA6625	22", 24", 25", 26" X 1" MAXXIS ALPHA PROTECT (protección antipinchazo) 3 mm	NUEVO	72,18
DCA6630	24" X 1" MBL SPEEDLITE - Neumático SUPERLIGERO, muy alta resistencia a los pinchazos		72,18
DCA6660	24" X 1.3/8" maciza negra	(NC : 6690, 7230)	72,18



5050/5300

5100/ 5350/
5550/5650

5200/5250/5450/5500



5600



6020



6040



6000/6010



6020



6510



6520



6550

Código	Descripción			P.V.P €
PROTECCIÓN ANTIPINCHAZO				
DCA6680	Protección antipinchazo			99,72
AROS DE PROPULSIÓN				
DCA6700	Antideslizantes 22", 24", 26" dist. 30 mm.	Lengüetas largas con 2 orificios distancia 30 o 40 mm, montados a 30 mm		161,09
DCA6710	Acero 24", 26", dist. 30 mm	Lengüetas cortas con un solo orificio, distancia 30 mm.		124,07
DCA6720	Titanio 24", dist. 30 mm	Lengüetas largas con 2 orificios distancia 30 o 40 mm, montados a 30 mm.		269,32
DCA6740	24" / 25" Carbolife Gekko L (banda antideslizante), dist. 30 cm (ancho total + 15 mm)	Lengüetas largas con 2 orificios distancia 30 o 40 cm, montados a 30 mm		349,80
DCA6750	24" / 25" Carbolife Gekko S (banda antideslizante), dist. 30 cm	Lengüetas largas con 2 orificios distancia 30 o 40 cm, montados a 30 mm		349,80
DCA6760	24" Carbolife CURVE L (perfil ergonómico), dist. 30 cm (ancho total + 15 mm)	Lengüetas largas con 2 orificios distancia 30 o 40 cm, montados a 30 mm.		330,12
DCA6770	24" Carbolife QUADRO, (perfil ergonómico y antideslizante) dist. 3 CM	Lengüetas largas con 2 orificios distancia 30 o 40 cm, montados a 30 mm		349,80
DCA6780	Aluminio ligero gris 22", 24", 25", 26", dist. 30 mm.	Lengüetas largas con 2 orificios distancia 30 o 40 mm, montados a 30 mm.		○
DCA6790	Aluminio ligero negro 22", 24", 25", 26", dist. 30 mm.	Lengüetas cortas con un solo orificio, distancia 30 mm.		○
CAIDA RUEDAS TRASERAS (CAMBER)				
DCA6820	◆	Caída 0°		◆
DCA6840		Caída 3°	(NC : 7230)	○
PROTECTORES RADIOS				
DCA6900	Transparentes 22", 24", 26"			161,92
DCA6910	Negros 22", 24", 26"			161,92
KIT DE FIJACIÓN ALBER				
DCA6950	Kit de fijación E-MOTION & TWION	2 antivuelcos abatibles ALBER incluidos / Solo con ruedas 24"	(NC : 7500, 7510, 7520, 8100, 8110, 8120, 8200, 8210)	625,48
SEGURIDAD				
FRENOS				Ver tabla 4
DCA7200	◆	Frenos de tiro		◆
DCA7210		Frenos estándar, palanca angulada	Por favor, tenga en cuenta que dependiendo de la configuración, los frenos pueden entrar en colisión con los pescantes o reposapiés	○
DCA7220		Frenos estándar, palanca recta	Por favor, tenga en cuenta que dependiendo de la configuración, los frenos pueden entrar en colisión con los pescantes o reposapiés	○
DCA7230		Frenos performance	(NC : 7300, 7810, 7820, 7830)	137,35
DCA7240		Frenos activos		81,03
DCA7250		Frenos activos ligeros	(NC : 7300)	140,60
PROLONGADOR PALANCA DE FRENO				
DCA7300	Prolongador palanca de freno			75,91
OPCIONES DE SEGURIDAD				
ANTIVUELCO				
Max. 2 adaptaciones por lado (adaptaciones = antivuelco, pisapié, soporte para bastones, ruedas transit)				
DCA7500	Antivuelco derecho			157,36
DCA7510	Antivuelco izquierdo			157,36
DCA7520	Antivuelco ambos lados			314,72
KIT DE TRANSPORTE				
DCA7600	Kit de transporte, incluye 4 pegatinas	No posible con BH ≤ 400 MM	(NC : 7800)	12,00
CINTURÓN POSTURAL				
DCA7800	Cinturón postural estándar			97,04
DCA7810	Cinturón postural BODYPOINT EVOFLEX 2 puntos, S, FLAT-MOUNT con hebilla estándar			113,72
DCA7820	Cinturón postural BODYPOINT EVOFLEX 2 puntos, M, FLAT-MOUNT con hebilla REHAB			113,72
DCA7830	Cinturón postural BODYPOINT EVOFLEX 2 puntos, L, FLAT-MOUNT con hebilla REHAB			113,72
ILUMINACIÓN PASIVA				
DCA7900	Iluminación pasiva (montada en los radios)			19,47
DCA7910	Iluminación pasiva sin montar			10,82
OPCIONES ACOMPAÑANTE				



ETRTO	
LENCO PRIMO SENTINEL :	
22" :	25-489
24" :	25-540
25" :	25-559
26" :	25-590
MAXXIS LIGHT GUARD :	
24" :	25-540
MBL SPEEDLITE :	
24" :	25-540

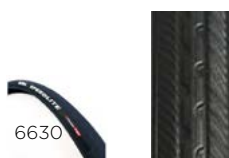

Freno activo	Profundidad asiento	Posición rueda trasera					
		1	2	3	4	5	6
ST32-38							
ST40							
ST42							
ST44							
ST46							
ST48							
ST50							

Código	Descripción	P.V.P €	
PROTECTOR DE CHASIS			
DCA8000	Protectores chasis (parte trasera), par	◆	
DCA8010	Protectores chasis (parte delantera), par	39,38	
PISAPIÉ Max. 2 adaptaciones por lado (adaptaciones = antivuelco, pisapié, soporte para bastones, ruedas transit)			
DCA8100	Pisapié derecho (NC : 8200)	70,59	
DCA8110	Pisapié izquierdo (NC: 8210)	70,59	
DCA8120	Pisapié ambos lados (NC : 8200, 8210)	141,18	
SOPORTE PARA BASTONES Max. 2 adaptaciones por lado (adaptaciones = antivuelco, pisapié, soporte para bastones, ruedas transit)			
DCA8200	Soporte para bastones, montaje derecha	86,61	
DCA8210	Soporte para bastones, montaje izquierda	86,61	
RUEDAS TRANSIT Max. 2 adaptaciones por lado (adaptaciones = antivuelco, pisapié, soporte para bastones, ruedas transit)			
DCA8300	Ruedas transit 3"	201,76	
OTRAS OPCIONES			
DCA8450	Mesita (solo con reposabrazos ajustables en altura)	519,86	
DCA8500	Bomba de hinchado - Nuevo	19,67	
DCA8550	Kit de herramientas	16,22	
DCA8650	Bolsa de transporte ruedas traseras (22", 24", 25", 26")	62,06	
DCA8680	Ruedas Mountain Bike 24" con bolsa de transporte	Ruedas Mountain Bike ,cubiertas y aros de aluminio grises, ejes Quick release incluidos	486,68
DCA8800	Panel pantorrilla BODYPOINT	81,11	
DCA8850	Bolsa movilidad BODYPOINT	91,93	

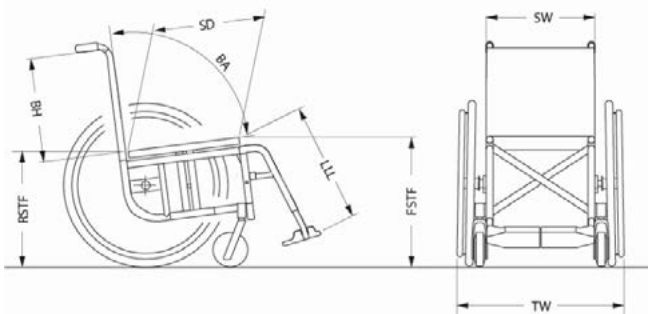

SW	Anchura de asiento
TW	Anchura total
BA	Ángulo de respaldo
BH	Altura de respaldo
SD	Profundidad de asiento
LLL	Largo de pierna
RSTF	Altura de asiento trasera
FSTF	Altura de asiento delantera

TABLA 1: Diámetro rueda delantera y altura de asiento delantera CHASIS ESTÁNDAR

Chasis	Montaje superior				Montaje estándar			
	4"	5"	6"	7"	4"	5"	6"	7"
Rueda delantera								
FSTF 380								
FSTF 390								
FSTF 400								
FSTF 410								
FSTF 420								
FSTF 430								
FSTF 440								
FSTF 450								
FSTF 460								
FSTF 470								
FSTF 480								
FSTF 490								
FSTF 500								
FSTF 510								
FSTF 520								
FSTF 530								
FSTF 540								
FSTF 550								

CHASIS HEMI *

Chasis	Montaje superior				Montaje estándar			
	4"	5"	6"	7"	4"	5"	6"	7"
FSTF 380	Green	Red	Red	Red	Red	Red	Red	Red
FSTF 390	Green	Red	Red	Red	Red	Red	Red	Red
FSTF 400	Green	Red	Red	Red	Red	Red	Red	Red
FSTF 410	Green	Green	Red	Red	Green	Red	Red	Red
FSTF 420	Green	Green	Red	Red	Green	Red	Red	Red
FSTF 430	Green	Green	Green	Red	Green	Red	Red	Red
FSTF 440	Green	Green	Green	Red	Green	Green	Red	Red
FSTF 450	Green	Green	Green	Red	Green	Green	Red	Red
FSTF 460	Green	Green	Green	Green	Green	Green	Red	Red
FSTF 470	Red	Green	Green	Green	Green	Green	Red	Red
FSTF 480	Red	Green	Green	Green	Green	Green	Red	Red
FSTF 490	Red	Green	Green	Green	Green	Green	Red	Red
FSTF 500	Red	Green	Green	Green	Green	Green	Red	Red
FSTF 510	Red	Green	Green	Green	Green	Green	Red	Red
FSTF 520	Red	Green	Green	Green	Green	Green	Red	Red
FSTF 530	Red	Green	Green	Green	Green	Green	Red	Red
FSTF 540	Red	Green	Green	Green	Green	Green	Red	Red
FSTF 550	Red	Green	Green	Green	Green	Green	Red	Red

* Solo para pescantes abatibles

CHASIS HEMI *

Rueda delantera	4"	5"	6"	7"
FSTF 380	Hemi	Red	Red	Red
FSTF 390	Hemi	Red	Red	Red
FSTF 400	Hemi	Red	Red	Red
FSTF 410	Hemi	Hemi	Red	Red
FSTF 420	Hemi	Hemi	Red	Red
FSTF 430	Hemi	Hemi	Hemi	Red
FSTF 440	Std	Hemi	Hemi	Red
FSTF 450	Std	Hemi	Hemi	Red
FSTF 460	Std	Hemi	Hemi	Hemi
FSTF 470	Std	Std	Hemi	Hemi
FSTF 480	Std	Std	Hemi	Hemi
FSTF 490	Std	Std	Std	Hemi
FSTF 500	Std	Std	Std	Hemi
FSTF 510	Std	Std	Std	Hemi
FSTF 520	Std	Std	Std	Std
FSTF 530	Std	Std	Std	Std
FSTF 540	Red	Red	Red	Red
FSTF 550	Red	Red	Red	Red

TABLA 2: MONTAJE PALETA (paleta, ángulo reposapiés, Largo de piernas)

- STD Paleta montaje estándar
- SUPERIOR Paleta montaje superior
- Configuración posible
- No Compatible

	Paleta estándar de composite				Paleta de carbono 1 - 2 partes			
	Abatibles		Fijos		Abatibles		Fijos	
	70°	80°	70°	80°	70°	80°	70°	80°
LLL 200	Red	Red	SUPERIOR	SUPERIOR	Red	Red	SUPERIOR	SUPERIOR
LLL 210	Red	Red	SUPERIOR	SUPERIOR	Red	SUPERIOR	SUPERIOR	SUPERIOR
LLL 220	Red	Red	SUPERIOR	SUPERIOR	SUPERIOR	SUPERIOR	SUPERIOR	SUPERIOR
LLL 230	Red	Red	SUPERIOR	SUPERIOR	SUPERIOR	SUPERIOR	SUPERIOR	SUPERIOR
LLL 240	Red	SUPERIOR	SUPERIOR	SUPERIOR	SUPERIOR	SUPERIOR	SUPERIOR	SUPERIOR
LLL 250	Red	SUPERIOR	SUPERIOR	SUPERIOR	SUPERIOR	SUPERIOR	SUPERIOR	SUPERIOR
LLL 260	SUPERIOR	SUPERIOR	SUPERIOR	SUPERIOR	SUPERIOR	SUPERIOR	SUPERIOR	SUPERIOR
LLL 270	SUPERIOR	SUPERIOR	SUPERIOR	SUPERIOR	SUPERIOR	STD	SUPERIOR	SUPERIOR
LLL 280	SUPERIOR	SUPERIOR	SUPERIOR	SUPERIOR	SUPERIOR	STD	SUPERIOR	SUPERIOR
LLL 290	SUPERIOR	SUPERIOR	SUPERIOR	SUPERIOR	STD	STD	SUPERIOR	SUPERIOR
LLL 300	SUPERIOR	SUPERIOR	SUPERIOR	SUPERIOR	STD	STD	SUPERIOR	STD
LLL 310	SUPERIOR	SUPERIOR	SUPERIOR	SUPERIOR	STD	STD	SUPERIOR	STD
LLL 320	SUPERIOR	STD	SUPERIOR	SUPERIOR	STD	STD	STD	STD
LLL 330	SUPERIOR	STD	SUPERIOR	SUPERIOR	STD	STD	STD	STD
LLL 340	SUPERIOR	STD	SUPERIOR	SUPERIOR	STD	STD	STD	STD
LLL 350	STD	STD	SUPERIOR	SUPERIOR	STD	STD	STD	STD
LLL 360	STD	STD	SUPERIOR	STD	STD	STD	STD	STD
LLL 370	STD	STD	STD	STD	STD	STD	STD	STD
LLL 380	STD	STD	STD	STD	STD	STD	STD	STD
LLL 390	STD	STD	STD	STD	STD	STD	STD	STD
LLL 400	STD	STD	STD	STD	STD	STD	STD	STD
LLL 410	STD	STD	STD	STD	STD	STD	STD	STD
LLL 420	STD	STD	STD	STD	STD	STD	STD	STD
LLL 430	STD	STD	STD	STD	STD	STD	STD	STD
LLL 440	STD	STD	STD	STD	STD	STD	STD	STD
LLL 450	STD	STD	STD	STD	STD	STD	STD	STD
LLL 460	STD	STD	STD	STD	STD	STD	STD	STD
LLL 470	STD	STD	STD	STD	STD	STD	STD	STD
LLL 480	STD	STD	STD	STD	STD	STD	STD	STD
LLL 490	STD	STD	STD	STD	STD	STD	STD	STD
LLL 500	STD	STD	STD	STD	STD	STD	STD	STD
LLL 510	STD	Red	STD	Red	STD	Red	STD	Red

TABLA 3

Protectores de composite y carbono / diámetro y posición rueda trasea

Posición	Rueda trasera 22"						Rueda trasera 24"						Rueda trasera 25"						Rueda trasera 26"					
	1	2	3	4	5	6	1	2	3	4	5	6	1	2	3	4	5	6	1	2	3	4	5	6
RSTF360																								
RSTF370																								
RSTF380																								
RSTF390																								
RSTF400																								
RSTF410																								
RSTF420																								
RSTF430																								
RSTF440																								
RSTF450																								
RSTF460																								
RSTF470																								
RSTF480																								
RSTF490																								
RSTF500																								

Protectores antisalpicaduras fijos y desmontables (plástico) / diámetro y posición rueda trasera

Posición	Rueda trasera 22"						Rueda trasera 24"						Rueda trasera 25"						Rueda trasera 26"					
	1	2	3	4	5	6	1	2	3	4	5	6	1	2	3	4	5	6	1	2	3	4	5	6
RSTF360																								
RSTF370																								
RSTF380																								
RSTF390																								
RSTF400																								
RSTF410																								
RSTF420																								
RSTF430																								
RSTF440																								
RSTF450																								
RSTF460																								
RSTF470																								
RSTF480																								
RSTF490																								
RSTF500																								

Protectores antisalpicaduras carbono (fijos y desmontables) / diámetro y posición rueda trasera

Posición	Rueda trasera 22"						Rueda trasera 24"						Rueda trasera 25"						Rueda trasera 26"					
	1	2	3	4	5	6	1	2	3	4	5	6	1	2	3	4	5	6	1	2	3	4	5	6
RSTF360																								
RSTF370																								
RSTF380																								
RSTF390																								
RSTF400																								
RSTF410																								
RSTF420																								
RSTF430																								
RSTF440																								
RSTF450																								
RSTF460																								
RSTF470																								
RSTF480																								
RSTF490																								
RSTF500																								

TABLA 4

Frenos en relación con posición, diámetro rueda trasera y profundidad asiento

	POSICIÓN RUEDA TRASERA	Rueda trasera 22"						Rueda trasera 24"						Rueda trasera 25"						Rueda trasera 26"					
		1	2	3	4	5	6	1	2	3	4	5	6	1	2	3	4	5	6	1	2	3	4	5	6
Frenos empuje	SD 320-380																								
	SD 400																								
	SD 420																								
	SD 440																								
	SD 460																								
	SD 480																								
	SD 500																								
Frenos tiro	SD 320-380																								
	SD 400																								
	SD 420																								
	SD 440																								
	SD 460																								
	SD 480																								
	SD 500																								
Frenos activos	SD 320-380																								
	SD 400																								
	SD 420																								
	SD 440																								
	SD 460																								
	SD 480																								
	SD 500																								
Frenos activos ligeros	SD 320-380																								
	SD 400																								
	SD 420																								
	SD 440																								
	SD 460																								
	SD 480																								
	SD 500																								

TABLA 6

Reposapiés ajustables en ángulo en relación con LLL (largo de pierna) y FSTF (altura asiento delantera)

LLL	FSTF	410	420	430	440	450	460	470	480	490	500	510	520	530
210														
220														
230														
240														
250														
260														
270														
280														
290														
300														
310														
320														
330														
340														
350														
360														
370														
380														
390														
400														
410														
420														
430														
440														
450														
460														
470														
480														
490														
500														
510														
520														
530														